

Figure # 1

Simple Capacitive Filter

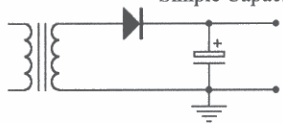

Figure # 2

Capacitive Input Filter, with Current Limiter



Figure # 3

RC Pi-Type Filter

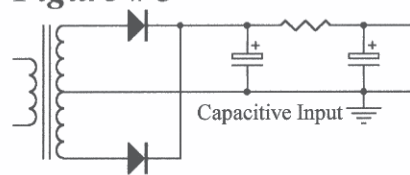

Figure # 4

Simple Inductor Filter

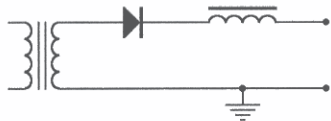

Figure # 5

LC L-Type Filter



Figure # 6

LC Pi-Type Filter

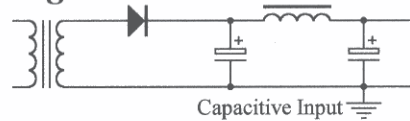

Figure # 7

12V-0V-12V Swinging Choke Smoothing Choke

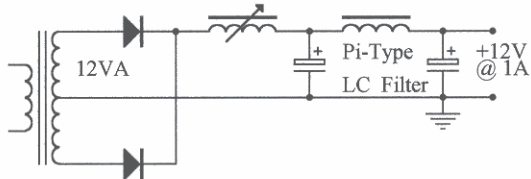

Figure # 8

12V-0V-12V

Capacitive Input Filter, with Low Ohms Current Limiter

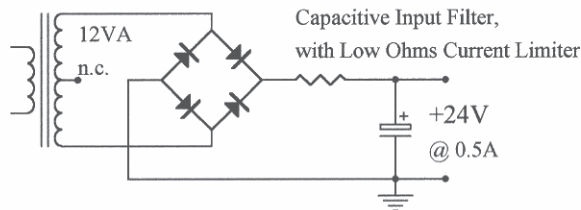

Figure # 9

Dual-Voltage Output P.S.

12V-0V-12V

Bridge Rectifier Component

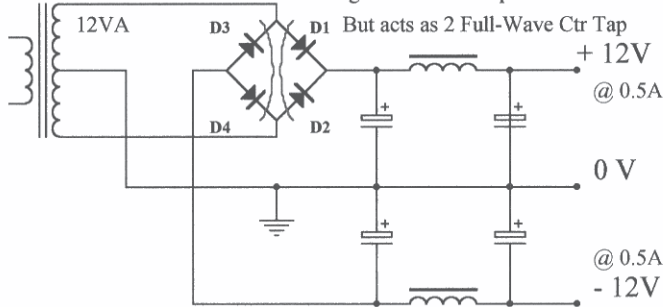
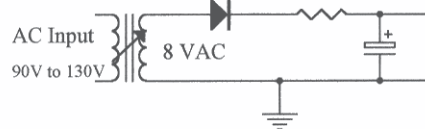

Figure # 10

XFMR Saturates at 90Vac Input Low Ohms



Title: **Power Supply Basic Circuits**

Size "A" **Solutions for Education**

Revision # 1

Date: 08/15/2001

Sheet 1 of 3 Sheet(s)

File: C:\CLIENT 3PwrCkts1.sch

Drawn by SFE-DCS, adf